

INSTRUCTION MANUAL



# Cordless Caulking Gun

DCG140

DCG180

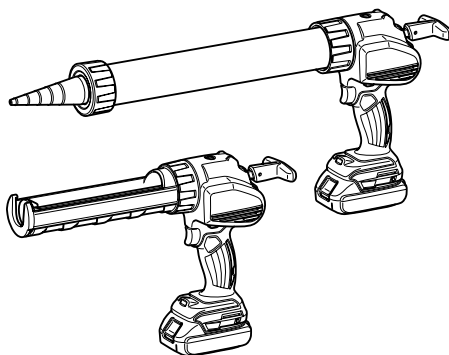

013564

**IMPORTANT:** Read Before Using.

## ENGLISH (Original instructions)

# SPECIFICATIONS

Model		DCG140		DCG180	
Max feed force		5000 N			
Feed speed		0 - 28 mm/s			
Stroke	with short (300 ml) holder	214 mm			
	with long (600 ml) holder	350 mm			
Overall length	with short (300 ml) holder	404 mm			
	with long (600 ml) holder	538 mm			
Standard battery cartridge		BL1415 / BL1415N	BL1430 / BL1440 / BL1450	BL1815 / BL1815N / BL1820 / BL1820B	BL1830 / BL1840 / BL1840B / BL1850 / BL1850B
Net weight	with short (300ml) holder	2.0 kg	2.2 kg	2.1 kg	2.3 kg
	with long (600ml) holder	2.4 kg	2.6 kg	2.5 kg	2.7 kg
Rated voltage		D.C. 14.4 V		D.C. 18 V	

- Due to our continuing program of research and development, the specifications herein are subject to change without notice.
- Specifications and battery cartridge may differ from country to country.
- Weight, with battery cartridge, according to EPTA-Procedure 01/2003

END004-6

GEA006-2

## Symbols

The following show the symbols used for the equipment. Be sure that you understand their meaning before use.



- Read instruction manual.



- Only for EU countries

Do not dispose of electric equipment or battery pack together with household waste material!

In observance of the European Directives, on Waste Electric and Electronic Equipment and Batteries and Accumulators and Waste Batteries and Accumulators and their implementation in accordance with national laws, electric equipment and batteries and battery pack(s) that have reached the end of their life must be collected separately and returned to an environmentally compatible recycling facility.

ENE086-1

## Intended use

This tool is intended for applying caulking material to surface.

## General Power Tool Safety Warnings

**⚠ WARNING** Read all safety warnings and all instructions. Failure to follow the warnings and instructions may result in electric shock, fire and/or serious injury.

## Save all warnings and instructions for future reference.

The term "power tool" in the warnings refers to your mains-operated (corded) power tool or battery-operated (cordless) power tool.

### Work area safety

1. **Keep work area clean and well lit.** Cluttered or dark areas invite accidents.
2. **Do not operate power tools in explosive atmospheres, such as in the presence of flammable liquids, gases or dust.** Power tools create sparks which may ignite the dust or fumes.
3. **Keep children and bystanders away while operating a power tool.** Distractions can cause you to lose control.

### Electrical safety

4. **Power tool plugs must match the outlet. Never modify the plug in any way. Do not use any adapter plugs with earthed (grounded) power tools.** Unmodified plugs and matching outlets will reduce risk of electric shock.
5. **Avoid body contact with earthed or grounded surfaces such as pipes, radiators, ranges and refrigerators.** There is an increased risk of electric shock if your body is earthed or grounded.

6. **Do not expose power tools to rain or wet conditions.** Water entering a power tool will increase the risk of electric shock.
7. **Do not abuse the cord. Never use the cord for carrying, pulling or unplugging the power tool. Keep cord away from heat, oil, sharp edges or moving parts.** Damaged or entangled cords increase the risk of electric shock.
8. **When operating a power tool outdoors, use an extension cord suitable for outdoor use.** Use of a cord suitable for outdoor use reduces the risk of electric shock.
9. **If operating a power tool in a damp location is unavoidable, use a ground fault circuit interrupter (GFCI) protected supply.** Use of an GFCI reduces the risk of electric shock.

#### Personal safety

10. **Stay alert, watch what you are doing and use common sense when operating a power tool. Do not use a power tool while you are tired or under the influence of drugs, alcohol or medication.** A moment of inattention while operating power tools may result in serious personal injury.
11. **Use personal protective equipment. Always wear eye protection.** Protective equipment such as dust mask, non-skid safety shoes, hard hat, or hearing protection used for appropriate conditions will reduce personal injuries.
12. **Prevent unintentional starting. Ensure the switch is in the off-position before connecting to power source and/or battery pack, picking up or carrying the tool.** Carrying power tools with your finger on the switch or energising power tools that have the switch on invites accidents.
13. **Remove any adjusting key or wrench before turning the power tool on.** A wrench or a key left attached to a rotating part of the power tool may result in personal injury.
14. **Do not overreach. Keep proper footing and balance at all times.** This enables better control of the power tool in unexpected situations.
15. **Dress properly. Do not wear loose clothing or jewellery. Keep your hair, clothing, and gloves away from moving parts.** Loose clothes, jewellery or long hair can be caught in moving parts.
16. **If devices are provided for the connection of dust extraction and collection facilities, ensure these are connected and properly used.** Use of dust collection can reduce dust-related hazards.

#### Power tool use and care

17. **Do not force the power tool. Use the correct power tool for your application.** The correct power tool will do the job better and safer at the rate for which it was designed.
18. **Do not use the power tool if the switch does not turn it on and off.** Any power tool that cannot be controlled with the switch is dangerous and must be repaired.
19. **Disconnect the plug from the power source and/or the battery pack from the power tool before making any adjustments, changing accessories, or storing power tools.** Such preventive safety measures reduce the risk of starting the power tool accidentally.
20. **Store idle power tools out of the reach of children and do not allow persons unfamiliar with the power tool or these instructions to operate the power tool.** Power tools are dangerous in the hands of untrained users.
21. **Maintain power tools. Check for misalignment or binding of moving parts, breakage of parts and any other condition that may affect the power tool's operation. If damaged, have the power tool repaired before use.** Many accidents are caused by poorly maintained power tools.
22. **Keep cutting tools sharp and clean.** Properly maintained cutting tools with sharp cutting edges are less likely to bind and are easier to control.
23. **Use the power tool, accessories and tool bits etc. in accordance with these instructions, taking into account the working conditions and the work to be performed.** Use of the power tool for operations different from those intended could result in a hazardous situation.

#### Battery tool use and care

24. **Recharge only with the charger specified by the manufacturer.** A charger that is suitable for one type of battery pack may create a risk of fire when used with another battery pack.
25. **Use power tools only with specifically designated battery packs.** Use of any other battery packs may create a risk of injury and fire.
26. **When battery pack is not in use, keep it away from other metal objects, like paper clips, coins, keys, nails, screws or other small metal objects, that can make a connection from one terminal to another.** Shorting the battery terminals together may cause burns or a fire.
27. **Under abusive conditions, liquid may be ejected from the battery; avoid contact. If contact accidentally occurs, flush with water. If liquid contacts eyes, additionally seek medical help.** Liquid ejected from the battery may cause irritation or burns.

## Service

28. **Have your power tool serviced by a qualified repair person using only identical replacement parts.** This will ensure that the safety of the power tool is maintained.
29. **Follow instruction for lubricating and changing accessories.**
30. **Keep handles dry, clean and free from oil and grease.**

GEB106-1

## CORDLESS CAULKING GUN SAFETY WARNINGS

1. Keep hands and clothes away from the rod and the plunger area. Otherwise your finger or clothes may be pinched.
2. Always be sure you have a firm footing.
3. Hold the tool firmly.
4. Always work in well ventilated area and wear proper protections in accordance with the operation.
5. Read and follow the manufacture's instructions on caulking material or adhesive material before usage.

## SAVE THESE INSTRUCTIONS.

### **WARNING:**

**DO NOT let comfort or familiarity with product (gained from repeated use) replace strict adherence to safety rules for the subject product. MISUSE or failure to follow the safety rules stated in this instruction manual may cause serious personal injury.**

ENC007-9

## IMPORTANT SAFETY INSTRUCTIONS

### FOR BATTERY CARTRIDGE

1. Before using battery cartridge, read all instructions and cautionary markings on (1) battery charger, (2) battery, and (3) product using battery.
2. Do not disassemble battery cartridge.
3. If operating time has become excessively shorter, stop operating immediately. It may result in a risk of overheating, possible burns and even an explosion.
4. If electrolyte gets into your eyes, rinse them out with clear water and seek medical attention right away. It may result in loss of your eyesight.

5. Do not short the battery cartridge:
  - (1) Do not touch the terminals with any conductive material.
  - (2) Avoid storing battery cartridge in a container with other metal objects such as nails, coins, etc.
  - (3) Do not expose battery cartridge to water or rain.

A battery short can cause a large current flow, overheating, possible burns and even a breakdown.

6. Do not store the tool and battery cartridge in locations where the temperature may reach or exceed 50 ° C (122 ° F).
7. Do not incinerate the battery cartridge even if it is severely damaged or is completely worn out. The battery cartridge can explode in a fire.
8. Be careful not to drop or strike battery.
9. Do not use a damaged battery.
10. Follow your local regulations relating to disposal of battery.

## SAVE THESE INSTRUCTIONS.

### Tips for maintaining maximum battery life

1. Charge the battery cartridge before completely discharged.  
Always stop tool operation and charge the battery cartridge when you notice less tool power.
2. Never recharge a fully charged battery cartridge.  
Overcharging shortens the battery service life.
3. Charge the battery cartridge with room temperature at 10 ° C - 40 ° C (50 ° F - 104 ° F). Let a hot battery cartridge cool down before charging it.
4. Charge the battery cartridge if you do not use it for a long period (more than six months).

## FUNCTIONAL DESCRIPTION

### ⚠ CAUTION:

- Always be sure that the tool is switched off and the battery cartridge is removed before adjusting or checking function on the tool.

### Installing or removing battery cartridge

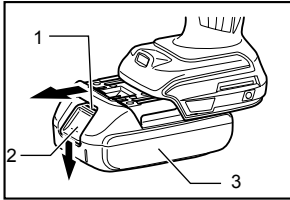

013558

1. Red indicator
2. Button
3. Battery cartridge

### ⚠ CAUTION:

- Always switch off the tool before installing or removing of the battery cartridge.
- Hold the tool and the battery cartridge firmly when installing or removing battery cartridge. Failure to hold the tool and the battery cartridge firmly may cause them to slip off your hands and result in damage to the tool and battery cartridge and a personal injury.

To remove the battery cartridge, slide it from the tool while sliding the button on the front of the cartridge.

To install the battery cartridge, align the tongue on the battery cartridge with the groove in the housing and slip it into place. Insert it all the way until it locks in place with a little click. If you can see the red indicator on the upper side of the button, it is not locked completely.

### ⚠ CAUTION:

- Always install the battery cartridge fully until the red indicator cannot be seen. If not, it may accidentally fall out of the tool, causing injury to you or someone around you.
- Do not install the battery cartridge forcibly. If the cartridge does not slide in easily, it is not being inserted correctly.

### Battery protection system

The tool is equipped with a battery protection system. This system automatically cuts off power to the motor to extend battery life.

The tool will automatically stop during operation if the tool and/or battery are placed under one of the following conditions:

- **Overloaded:**  
The tool is operated in a manner that causes it to draw an abnormally high current. In this situation, release the switch trigger on the tool and stop the application that caused the tool to become overloaded. Then pull the switch trigger again to restart. If the tool does not start, the battery is overheated. In this situation, let the battery cool before pulling the switch trigger again.
- **Low battery voltage:**  
The remaining battery capacity is too low and the tool will not operate. In this situation, remove and recharge the battery.

### NOTE:

The overheat protection works only with a battery cartridge with a star mark.

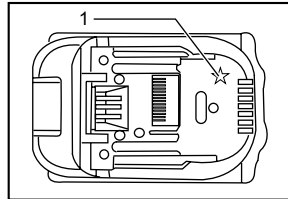

012128

1. Star marking

### Indicating the remaining battery capacity

(Only for battery cartridges with "B" at the end of the model number.)

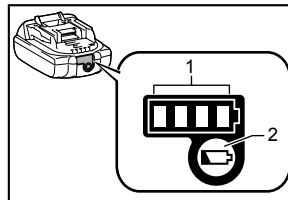

015659

1. Indicator lamps
2. Check button

Press the check button on the battery cartridge to indicate the remaining battery capacity. The indicator lamps light up for few seconds.

Indicator lamps			Remaining capacity
Lighted	Off	Blinking	
■	□	◻	75% to 100%
■	■	■	
■	■	□	50% to 75%
■	□	□	25% to 50%
■	□	□	0% to 25%
◻	□	□	Charge the battery.
◻	■	□	The battery may have malfunctioned.
◻	□	■	

015658

**NOTE:**

- Depending on the conditions of use and the ambient temperature, the indication may differ slightly from the actual capacity.

**Speed adjusting dial**

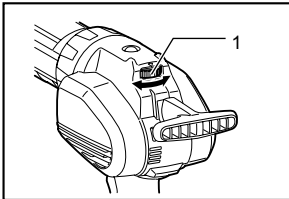

1. Speed adjusting dial

013560

The tool speed can be adjusted by turning the dial. Higher speed is obtained when the dial is turned in the direction of number 5, lower speed is obtained when it is turned in the direction of number 1.

**NOTE:**

- The speed adjusting dial can be turned only as far as 5 and back to 1. Do not force it past 5 or 1, or the speed adjusting function may no longer work.
- Depending on the type and condition of caulking material, the rod may get clogged when operating with low speed. In that case set the speed adjusting dial higher.

**Overload warning lamp**

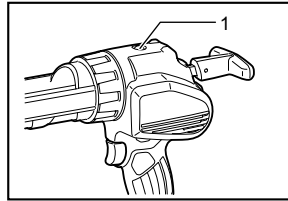

1. Warning lamp

013557

The warning lamp flickers in red when the tool is overloaded. If the load reaches some point, the lamp keeps lighting in red and the tool stops. To restart the tool, release the trigger and pull the trigger again.

**NOTE:**

Check what causes the overload when the lamp flickers or lights up. Change the parameter of the speed adjusting dial lower, or increase the diameter of the nozzle.

**Switch action**

**CAUTION:**

- Before inserting the battery cartridge into the tool, always check to see that the switch trigger actuates properly and returns to the "OFF" position when released.
- When not operating the tool, push the trigger-lock button from A side to lock the switch trigger in the OFF position.

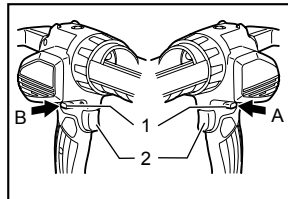

1. Lock lever  
2. Switch trigger

013559

To prevent the switch trigger from accidentally pulled, the trigger-lock button is provided.

To start the tool, push the trigger-lock button from B side and pull the switch trigger. Tool speed is increased by increasing pressure on the switch trigger. Release the switch trigger to stop.

After use, press in the trigger-lock button from A side.

## Lighting up the lamp

### ⚠CAUTION:

- Do not look in the light or see the source of light directly.

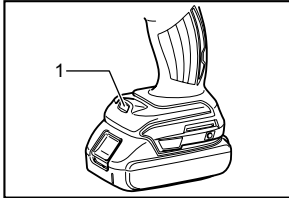

1. Lamp

013570

Pull the switch trigger to light up the lamp. The lamp keeps on lighting while the switch trigger is being pulled. The lamp goes out approximately 10 seconds after the switch trigger is released.

### NOTE:

- Use a dry cloth to wipe the dirt off the lens of lamp. Be careful not to scratch the lens of lamp, or it may lower the illumination.
- When the tool is overheated, the lamp flickers. Cool down the tool fully before operating again.

## Drip preventive function

The motor keeps running for a short time even after the trigger is released. It releases the pressure of the caulking material and prevents dripping.

## ASSEMBLY

### ⚠CAUTION:

- Always be sure that the tool is switched off and the battery cartridge is removed before carrying out any work on the tool.
- Always place the tool on the ground or workbench when carrying out any assembling work. The tool without being held tight may lose balance and cause injury.

## Installing holder joint

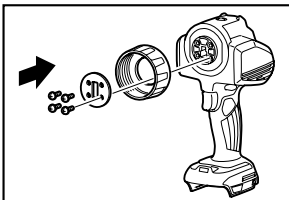

013610

Attach the holder joint firmly along the tool, set the plate, and fix them with screws tightly.

To remove the holder joint, follow above procedure in reverse.

### NOTE:

- There are two types of holders (optional accessory), short holder (300ml) and long holder (600ml). Use appropriate holder joint accordingly.

## Installing rod and piston

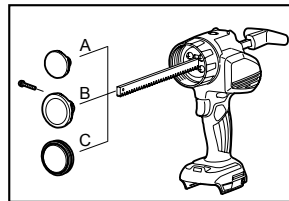

013612

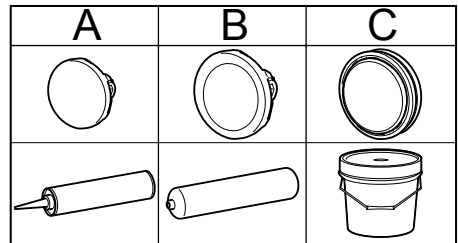

013611

Insert the rod into the slit of the tool.

Attach the piston and tighten it with a screw.

To remove the rod and piston, follow the installation procedure in reverse.

### NOTICE:

- The teeth on the rod must point down.
- There are three types of pistons. Piston A for cartridges. Piston B for film type packs. Piston C for direct filling.
- Choose appropriate piston in accordance with the type of caulking material container. Improper piston may cause leakage or tool breakage.
- There are two types of rods. The short rod for the short holder (300ml), and the long rod for long holder (600ml). Use appropriate rod in accordance with holder type.
- Always keep the rod and piston clean. Adhering caulk may damage the tool.

## Installing holder

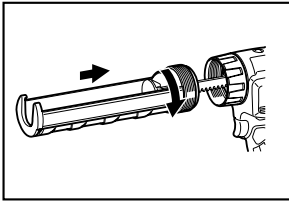

013561

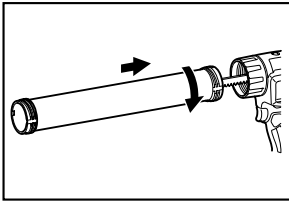

013562

Hold the bottom of the holder and the holder joint, then turn the holder clockwise. Tighten it firmly until it stops. Make sure the holder is tightened firmly. Otherwise the tool may be damaged.

To remove the holder, turn it counter clockwise.

### NOTE:

- You can rotate the holder in accordance with required situations to facilitate the operation.
- The short holder (300ml) is intended for the cartridges only. Use only piston A with short holder (300ml), and do not use it with film type packs or direct filling. Also use appropriate rod in accordance with the holder type.

## Installing cartridge

### NOTICE:

- Make sure the piston A is attached to the rod. Do not use other type of piston for cartridge.

### Installing the cartridge into the short holder (300ml)

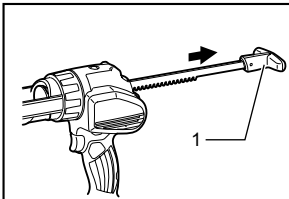

013566

Pull the rod handle backwards slowly until it stops.

1. Rod handle

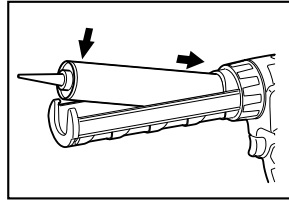

013567

Insert the cartridge into the holder as illustrated.

Push the rod gently until the piston touches the bottom of the cartridge.

To remove the cartridge, pull the rod backwards until it stops, then lift out the cartridge.

### Installing the cartridge into the long holder (600ml)

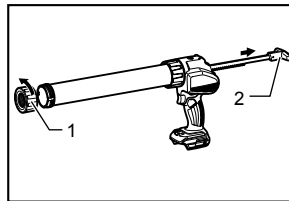

013572

Remove the holder cap from the holder.

Pull the rod handle backwards slowly until it stops.

1. Holder cap  
2. Rod handle

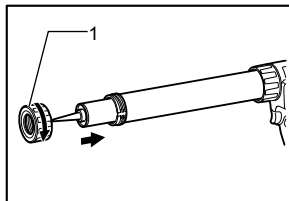

013571

Insert the cartridge into the holder.

Attach the holder cap. Make sure it is tightened firmly.

Push the rod gently until the piston touches the bottom of the cartridge.

To remove the cartridge, remove the holder cap, then take out the cartridge.

### NOTICE:

- Always check the cartridge for puncture or damage before installing. Do not use damaged cartridge, otherwise the tool may be damaged.
- When using a partially used cartridge, remove any adhered material on the cartridge.

1. Holder cap



## Installing film type pack

### NOTICE:

- Make sure the piston B is attached to the rod. Do not use other type of piston for film type pack.
- Film type pack can be installed in the long holder (600ml) only.

Remove the holder cap, the nozzle and the rubber ring from the holder.

Pull the rod handle backwards slowly until it stops.

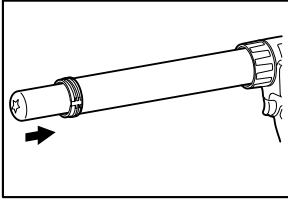

013555

Cut off the tip of the film type pack.  
Insert the film type pack into the holder.

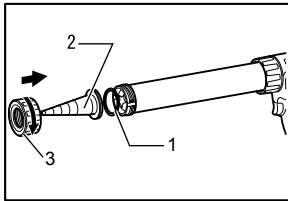

1. Rubber ring
2. Nozzle
3. Holder cap

013569

Attach the rubber ring, the nozzle and the holder cap. Make sure holder cap is tightened firmly. Push the rod gently until the piston touches the bottom of the film type pack.

### NOTE:

- Always check the film type pack for puncture or damage before installing. Do not use damaged pack, otherwise the tool may be damaged.

## Direct filling

### NOTICE:

- Make sure the piston C is attached to the rod. Do not use other type of piston for direct filling.
- Direct filling can only be performed with the long holder (600ml).

Remove the holder cap, the nozzle and the rubber ring from the holder.

Make sure the rod handle is placed at the most front position.

Dip the mouth of the holder into the caulking material.

Pull the rod handle slowly until required amount of caulking material is filled in the holder.

Attach the rubber ring, the nozzle and the holder cap. Make sure holder cap is tightened firmly.

### NOTICE:

- Clean the holder with appropriate solvent after every day's work. Otherwise adhered caulking material may cause tool breakage.

## OPERATION

### ⚠CAUTION:

- Do not touch the rod during operation. Otherwise your finger may be pinched between the rod and the housing of the tool.
- Always wear goggles during operation.

### NOTICE:

- Do not cover vents, or it may cause overheating and damage to the tool.
- If you can not pull out the rod, turn the speed adjusting dial to 1, and pull the switch trigger for a moment, and try to pull the rod out after the motor stopped. If the rod is still clogged, perform the same action until the rod is able to move.

Cut off the tip of the nozzle suitable for individual operation. Be careful how much you cut the nozzle. The diameter of the nozzle affects the amount of caulking material dispensed.

Pull the trigger to dispense caulking material.

The amount of the caulking material dispensed is determined by the trigger, the speed adjusting dial, the diameter of the nozzle opening, caulking material type, and temperature.

It is recommended that the speed adjusting dial is set to '1' and pull the trigger slowly at the first time to test how much amount of caulking material is dispensed.

When the rod reaches front end, the motor starts idling. Replace the caulking material when it happens.

### NOTE:

If the caulking material is not dispensed, check the following items:

- Nozzle tip is not cut adequately. Cut the nozzle tip suitable for individual operation.
- Hardened material gets clogged in the nozzle. Remove the hardened material.
- The cartridge is damaged. Replace the cartridge.
- Caulking material is stiff. Warm the material until it becomes soft.
- The wrong piston is used. Use appropriate piston.

---

## MAINTENANCE

### CAUTION:

- Always be sure that the tool is switched off and the battery cartridge is removed before attempting to perform inspection or maintenance except for the following troubleshooting related to the light.
- Never use gasoline, benzine, thinner, alcohol or the like. Discoloration, deformation or cracks may result.
- Clean the holder and the rod after every day's work. Keep them free from the adhesive material. Remove the caulking material before it hardens. Remained adhesive material may cause breakage of the tool.

To maintain product SAFETY and RELIABILITY, repairs, carbon brush inspection and replacement, any other maintenance or adjustment should be performed by Makita Authorized Service Centers, always using Makita replacement parts.

## OPTIONAL ACCESSORIES

### CAUTION:

- These accessories or attachments are recommended for use with your Makita tool specified in this manual. The use of any other accessories or attachments might present a risk of injury to persons. Only use accessory or attachment for its stated purpose.

If you need any assistance for more details regarding these accessories, ask your local Makita Service Center.

- Piston A
- Piston B
- Piston C
- Short holder (300ml) set
- Long holder (600ml) set
- Nozzle
- Safety goggles
- Makita genuine battery and charger

### NOTE:

- Some items in the list may be included in the tool package as standard accessories. They may differ from country to country.



Makita Corporation