

INSTRUCTION MANUAL

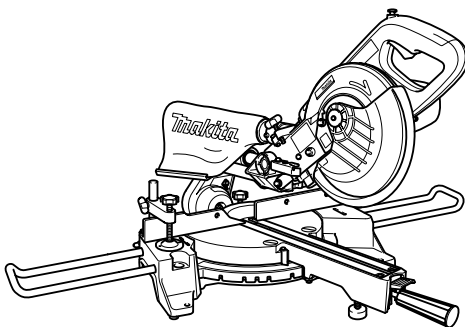

Slide Compound Saw

LS0714
LS0714F
LS0714FL
LS0714L



005515

 DOUBLE INSULATION

IMPORTANT: Read Before Using.

ENGLISH (Original instructions)

SPECIFICATIONS

Model	LS0714/ LS0714F/ LS0714FL/LS0714L
Blade diameter	190 mm
Blade body thickness	1.3 mm - 2.0 mm
Hole (arbor) diameter	20 mm
Max. Miter angle	Left 47° , Right 57°
Max. Bevel angle	Left 45°, Right 5°
Max. Cutting capacities (H x W) with blade 190 mm in diameter.	

Miter angle	Bevel angle		
	45° (left)	0°	5° (right)
0°	* 45 mm x 265 mm Note1	* 60 mm x 265 mm Note 1	----
	40 mm x 300 mm	52 mm x 300 mm	40 mm x 300 mm
45° (left and right)	* 45 mm x 185 mm Note2	* 60 mm x 185 mm Note 2	----
	40 mm x 212 mm	52 mm x 212 mm	
57° (right)	----	* 60 mm x 145 mm Note 3	----
		52 mm x 163 mm	

(Note)

* mark indicates that a wood facing with the following thickness is used.

- 1: When using a wood facing 20 mm thick.
- 2: When using a wood facing 15 mm thick.
- 3: When using a wood facing 10 mm thick.

No load speed (min ⁻¹)	6,000
Laser Type (LS0714FL/L)	Red Laser 650 nm, < 1mW (Laser Class 2)
Dimensions (L x W x H)	670 mm x 430 mm x 458 mm
Net weight	LS0714: 13.1 kg, LS0714F: 13.4 kg, LS0714FL: 13.7 kg, LS0714L: 13.5 kg

- Due to our continuing programme of research and development, the specifications herein are subject to change without notice.
- Specifications may differ from country to country.
- Weight according to EPTA-Procedure 01/2003

Symbols

The following show the symbols used for the equipment. Be sure that you understand their meaning before use.



- Read instruction manual.



- DOUBLE INSULATION



- To avoid injury from flying debris, keep holding the saw head down, after making cuts, until the blade has come to a complete stop.



- When performing slide cut, first pull carriage fully and press down handle, then push carriage toward the guide fence.

END210-6



- Do not place hand or fingers close to the blade.
- Never look into the laser beam. Direct laser beam may injure your eyes.
- Only for EU countries
Do not dispose of electric equipment together with household waste material! In observance of European Directive 2002/96/EC on waste electric and electronic equipment and its implementation in accordance with national law, electric equipment that have reached the end of their life must be collected separately and returned to an environmentally compatible recycling facility.

Intended use

The tool is intended for accurate straight and miter cutting in wood. With appropriate saw blades, aluminum can also be sawed.

ENF002-2

Power supply

The tool should be connected only to a power supply of the same voltage as indicated on the nameplate, and can only be operated on single-phase AC supply. They are double-insulated and can, therefore, also be used from sockets without earth wire.

ENG905-1

Noise

The typical A-weighted noise level determined according to EN61029:

Sound pressure level (L_{pA}) : 92 dB(A)

Sound power level (L_{WA}) : 101 dB(A)

Uncertainty (K) : 3 dB(A)

Wear ear protection

ENG900-1

Vibration

The vibration total value (tri-axial vector sum) determined according to EN61029:

Vibration emission (a_h) : 2.5 m/s² or less

Uncertainty (K) : 1.5 m/s²

ENG901-1

- The declared vibration emission value has been measured in accordance with the standard test method and may be used for comparing one tool with another.
- The declared vibration emission value may also be used in a preliminary assessment of exposure.

⚠WARNING:

- The vibration emission during actual use of the power tool can differ from the declared emission value depending on the ways in which the tool is used.
- Be sure to identify safety measures to protect the operator that are based on an estimation of exposure in the actual conditions of use (taking account of all parts of the operating cycle such as the times when the tool is switched off and when it is running idle in addition to the trigger time).

For European countries only**EC Declaration of Conformity**

We Makita Corporation as the responsible manufacturer declare that the following Makita machine(s):

Designation of Machine:

Slide Compound Saw

Model No./ Type: LS0714, LS0714F, LS0714FL, LS0714L are of series production and

Conforms to the following European Directives:
2006/42/EC

And are manufactured in accordance with the following standards or standardised documents:

EN61029

The technical documentation is kept by our authorised representative in Europe who is:

Makita International Europe Ltd.

Michigan Drive, Tongwell,

Milton Keynes, Bucks MK15 8JD, England

30. 1. 2009



000230

Tomoyasu Kato

Director

Makita Corporation

3-11-8, Sumiyoshi-cho,
Anjo, Aichi, 446-8502, JAPAN

ENA001-2

SAFETY INSTRUCTIONS

WARNING! When using electric tools, basic safety precautions, including the following, should always be followed to reduce the risk of fire, electric shock and personal injury. Read all these instructions before operating this product and save these instructions.

For safe operations:

1. **Keep work area clean.**
Cluttered areas and benches invite injuries.
2. **Consider work area environment.**
Do not expose power tools to rain. Do not use power tools in damp or wet locations. Keep work area well lit. Do not use power tools where there is risk to cause fire or explosion.
3. **Guard against electric shock.**
Avoid body contact with earthed or grounded surfaces (e.g. pipes, radiators, ranges, refrigerators).

4. **Keep children away.**
Do not let visitors touch the tool or extension cord. All visitors should be kept away from work area.
5. **Store idle tools.**
When not in use, tools should be stored in a dry, high or locked up place, out of reach of children.
6. **Do not force the tool.**
It will do the job better and safer at the rate for which it was intended.
7. **Use the right tool.**
Do not force small tools or attachments to do the job of a heavy duty tool. Do not use tools for purposes not intended; for example, do not use circular saws to cut tree limbs or logs.
8. **Dress properly.**
Do not wear loose clothing or jewellery, they can be caught in moving parts. Rubber gloves and non-skid footwear are recommended when working outdoors. Wear protecting hair covering to contain long hair.
9. **Use safety glasses and hearing protection.**
Also use face or dust mask if the cutting operation is dusty.
10. **Connect dust extraction equipment.**
If devices are provided for the connection of dust extraction and collection facilities ensure these are connected and properly used.
11. **Do not abuse the cord.**
Never carry the tool by the cord or yank it to disconnect it from the socket. Keep the cord away from heat, oil and sharp edges.
12. **Secure work.**
Use clamps or a vice to hold the work. It is safer than using your hand and it frees both hands to operate the tool.
13. **Do not overreach.**
Keep proper footing and balance at all times.
14. **Maintain tools with care.**
Keep cutting tools sharp and clean for better and safer performance. Follow instructions for lubrication and changing accessories. Inspect tool cord periodically and if damaged have it repaired by an authorized service facility. Inspect extension cords periodically and replace, if damaged. Keep handles dry, clean and free from oil and grease.
15. **Disconnect tools.**
When not in use, before servicing and when changing accessories such as blades, bits and cutters.
16. **Remove adjusting keys and wrenches.**
Form the habit of checking to see that keys and adjusting wrenches are removed from the tool before turning it on.
17. **Avoid unintentional starting.**
Do not carry a plugged-in tool with a finger on the switch. Ensure switch is off when plugging in.
18. **Use outdoor extension leads.**
When tool is used outdoors, use only extension cords intended for outdoor use.
19. **Stay alert.**
Watch what you are doing. Use common sense. Do not operate tool when you are tired.
20. **Check damaged parts.**
Before further use of the tool, a guard or other part that is damaged should be carefully checked to determine that it will operate properly and perform its intended function. Check for alignment of moving parts, free running of moving parts, breakage of parts, mounting and any other conditions that may affect its operation. A guard or other part that is damaged should be properly repaired or replaced by an authorized service center unless otherwise indicated in this instruction manual. Have defective switches replaced by an authorized service facility. Do not use the tool if the switch does not turn it on and off.
21. **Warning.**
The use of any accessory or attachment, other than those recommended in this instruction manual or the catalog, may present a risk of personal injury.
22. **Have your tool repaired by a qualified person.**
This electric tool is in accordance with the relevant safety requirements. Repairs should only be carried out by qualified persons using original spare parts, otherwise this may result in considerable danger to the user.

ENB034-6

ADDITIONAL SAFETY RULES FOR TOOL

1. **Wear eye protection.**
2. **Keep hands out of path of saw blade. Avoid contact with any coasting blade. It can still cause severe injury.**
3. **Do not operate saw without guards in place. Check blade guard for proper closing before each use. Do not operate saw if blade guard does not move freely and close instantly. Never clamp or tie the blade guard into the open position.**
4. **Do not perform any operation freehand.** The workpiece must be secured firmly against the turn base and guide fence with the vise during all operations. Never use your hand to secure the workpiece.
5. **Never reach around saw blade.**

6. Turn off tool and wait for saw blade to stop before moving workpiece or changing settings.
7. Unplug tool before changing blade or servicing.
8. Always secure all moving portions before carrying the tool.
9. Stopper pin which locks the cutter head down is for carrying and storage purposes only and not for any cutting operations.
10. Do not use the tool in the presence of flammable liquids or gases. The electrical operation of the tool could create an explosion and fire when exposed to flammable liquids or gases.
11. Check the blade carefully for cracks or damage before operation.
Replace cracked or damaged blade immediately.
12. Use only flanges specified for this tool.
13. Be careful not to damage the arbor, flanges (especially the installing surface) or bolt. Damage to these parts could result in blade breakage.
14. Make sure that the turn base is properly secured so it will not move during operation.
15. For your safety, remove the chips, small pieces, etc. from the table top before operation.
16. Avoid cutting nails. Inspect for and remove all nails from the workpiece before operation.
17. Make sure the shaft lock is released before the switch is turned on.
18. Be sure that the blade does not contact the turn base in the lowest position.
19. Hold the handle firmly. Be aware that the saw moves up or down slightly during start-up and stopping.
20. Make sure the blade is not contacting the workpiece before the switch is turned on.
21. Before using the tool on an actual workpiece, let it run for a while. Watch for vibration or wobbling that could indicate poor installation or a poorly balanced blade.
22. Wait until the blade attains full speed before cutting.
23. Stop operation immediately if you notice anything abnormal.
24. Do not attempt to lock the trigger in the on position.
25. Be alert at all times, especially during repetitive, monotonous operations. Do not be lulled into a false sense of security. Blades are extremely unforgiving.
26. Always use accessories recommended in this manual. Use of improper accessories such as abrasive wheels may cause an injury.
27. Do not use the saw to cut other than wood, aluminum or similar materials.
28. Connect miter saws to a dust collecting device when sawing.
29. Select saw blades in relation to the material to be cut.
30. Take care when slotting.
31. Replace the kerf board when worn.
32. Do not use saw blades manufactured from high speed steel.
33. Some dust created from operation contains chemicals known to cause cancer, birth defects or other reproductive harm. Some examples of these chemicals are:
 - lead from lead-based-painted material and,
 - arsenic and chromium from chemically-treated lumber.
 Your risk from these exposures varies, depending on how often you do this type of work. To reduce your exposure to these chemicals: work in a well ventilated area and work with approved safety equipment, such as those dust masks that are specially designed to filter out microscopic particles.
34. To reduce the emitted noise, always be sure that the blade is sharp and clean.
35. The operator is adequately trained in the use, adjustment and operation of the machine.
36. Use correctly sharpened saw blades. Observe the maximum speed marked on the saw blade.
37. Refrain from removing any cut-offs or other parts of the workpiece from the cutting area whilst the tool is running and the saw head is not in the rest position.
38. Use only saw blades recommended by the manufacturer which conform to EN847-1.
39. Wear gloves for handling saw blade (saw blades shall be carried in a holder wherever practicable) and rough material.
40. When fitted with laser, no exchange with different type of laser is permitted. Repairs shall only be carried out correctly.

SAVE THESE INSTRUCTIONS.

INSTALLATION

Bench mounting

When the tool is shipped, the handle is locked in the lowered position by the stopper pin. Release the stopper pin by lowering the handle slightly and pulling the stopper pin.

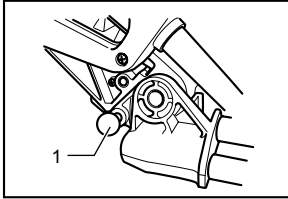

1. Stopper pin

003923

This tool should be bolted with two bolts to a level and stable surface using the bolt holes provided in the tool's base. This will help prevent tipping and possible injury.

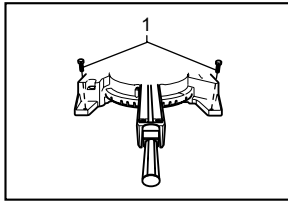

1. Bolt

003924

Turn the adjusting bolt clockwise or counterclockwise so that it comes into a contact with the floor surface to keep the tool stable.

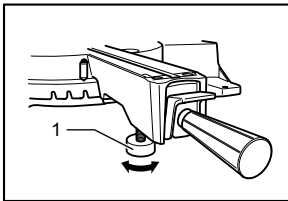

1. Adjusting bolt

003925

FUNCTIONAL DESCRIPTION

⚠WARNING:

- Always be sure that the tool is switched off and unplugged before adjusting or checking function on the tool.

Blade guard

For all countries other than European countries

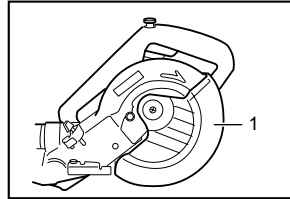

1. Blade guard

002252

When lowering the handle, the blade guard rises automatically. The guard is spring loaded so it returns to its original position when the cut is completed and the handle is raised. NEVER DEFEAT OR REMOVE THE BLADE GUARD OR THE SPRING WHICH ATTACHES TO THE GUARD.

In the interest of your personal safety, always maintain the blade guard in good condition. Any irregular operation of the blade guard should be corrected immediately. Check to assure spring loaded return action of guard. NEVER USE THE TOOL IF THE BLADE GUARD OR SPRING ARE DAMAGED, FAULTY OR REMOVED. DOING SO IS HIGHLY DANGEROUS AND CAN CAUSE SERIOUS PERSONAL INJURY.

For European countries

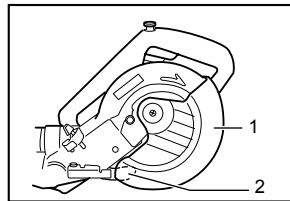

1. Blade guard A
2. Blade guard B
(For European countries)

006661

When lowering the handle, the blade guard A rises automatically. The blade guard B rises as it contacts a workpiece. The guards are spring loaded so it returns to its original position when the cut is completed and the handle is raised. NEVER DEFEAT OR REMOVE THE BLADE GUARDS OR THE SPRING WHICH ATTACHES TO THE GUARD.

In the interest of your personal safety, always maintain each blade guard in good condition. Any irregular operation of the blade guards should be corrected

immediately. Check to assure spring loaded return action of guards. NEVER USE THE TOOL IF THE BLADE GUARDS OR SPRING ARE DAMAGED, FAULTY OR REMOVED. DOING SO IS HIGHLY DANGEROUS AND CAN CAUSE SERIOUS PERSONAL INJURY.

If the see-through blade guard becomes dirty, or sawdust adheres to it in such a way that the blade is no longer easily visible, unplug the saw and clean the guard carefully with a damp cloth. Do not use solvents or any petroleum-based cleaners on the plastic guard.

If the blade guard is especially dirty and vision through the guard is impaired, use the supplied hex wrench to loosen the hex socket bolt holding the center cover. Loosen the hex socket bolt by turning it counterclockwise and raise the blade guard and center cover. With the blade guard so positioned, cleaning can be more completely and efficiently accomplished. When cleaning is complete, reverse procedure above and secure bolt. Do not remove spring holding blade guard. If guard becomes discolored through age or UV light exposure, contact a Makita service center for a new guard. DO NOT DEFEAT OR REMOVE GUARD.

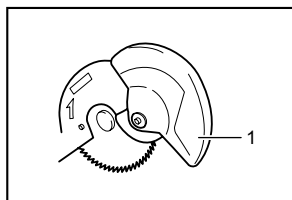

1. Blade guard

001782

Positioning kerf board

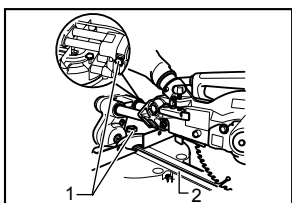

1. Thumb screw
2. Kerf board

003926

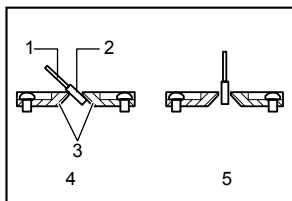

1. Saw blade
2. Blade teeth
3. Kerf board
4. Left bevel cut
5. Straight cut

001800

This tool is provided with the kerf boards in the turn base to minimize tearing on the exit side of a cut. The kerf

boards are factory adjusted so that the saw blade does not contact the kerf boards. Before use, adjust the kerf boards as follows:

First, unplug the tool. Loosen all the screws (2 each on left and right) securing the kerf boards. Re-tighten them only to the extent that the kerf boards can still be easily moved by hand. Lower the handle fully and push in the stopper pin to lock the handle in the lowered position. Loosen two clamp screws which secure the slide poles. Pull the carriage toward you fully. Adjust the kerf boards so that the kerf boards just contact the sides of the blade teeth. Tighten the front screws (do not tighten firmly). Push the carriage toward the guide fence fully and adjust the kerf boards so that the kerf boards just contact the sides of blade teeth. Tighten the rear screws (do not tighten firmly).

After adjusting the kerf boards, release the stopper pin and raise the handle. Then tighten all the screws securely.

⚠CAUTION:

- Before and after changing the bevel angle, always adjust the kerf boards as described above.

Maintaining maximum cutting capacity

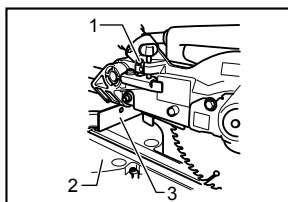

1. Adjusting bolt
2. Turn base
3. Guide fence

003927

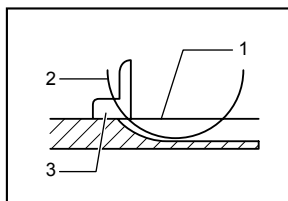

1. Top surface of turn table
2. Periphery of blade
3. Guide fence

005516

This tool is factory adjusted to provide the maximum cutting capacity for a 190 mm saw blade.

When installing a new blade, always check the lower limit position of the blade and if necessary, adjust it as follows: First, unplug the tool. Push the carriage toward the guide fence fully and lower the handle completely. Use the hex wrench to turn the adjusting bolt until the periphery of the blade extends slightly below the top surface of the turn base at the point where the front face of the guide fence meets the top surface of the turn base.

With the tool unplugged, rotate the blade by hand while holding the handle all the way down to be sure that the blade does not contact any part of the lower base. Re-adjust slightly, if necessary.

⚠WARNING:

- After installing a new blade, always be sure that the blade does not contact any part of the lower base when the handle is lowered completely. Always do this with the tool unplugged.

Stopper arm

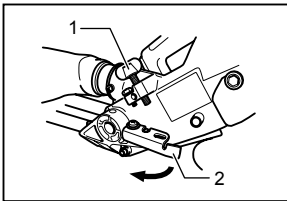

003928

1. Adjusting screw
2. Stopper arm

The lower limit position of the blade can be easily adjusted with the stopper arm. To adjust it, move the stopper arm in the direction of the arrow as shown in the figure. Adjust the adjusting screw so that the blade stops at the desired position when lowering the handle fully.

Adjusting the miter angle

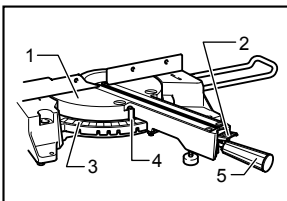

003929

1. Turn base
2. Lock lever
3. Miter scale
4. Pointer
5. Grip

Loosen the grip by turning counterclockwise. Turn the turn base while pressing down the lock lever. When you have moved the grip to the position where the pointer points to the desired angle on the miter scale, securely tighten the grip clockwise.

⚠CAUTION:

- When turning the turn base, be sure to raise the handle fully.
- After changing the miter angle, always secure the turn base by tightening the grip firmly.

Adjusting the bevel angle

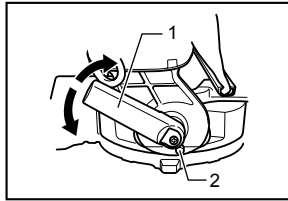

003930

1. Lever
2. Release button

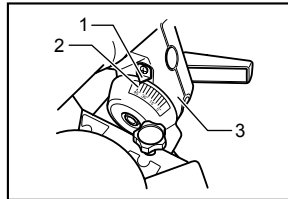

003931

1. Pointer
2. Bevel scale
3. Arm

To adjust the bevel angle, loosen the lever at the rear of the tool counterclockwise.

Push the handle to the left to tilt the saw blade until the pointer points to the desired angle on the bevel scale. Then tighten the lever clockwise firmly to secure the arm. To tilt the blade to the right, push the release button at the rear of the tool while tilting the blade slightly to the left after loosening the lever. With the release button depressed, tilt the saw blade to the right.

⚠CAUTION:

- When tilting the saw blade, be sure to raise the handle fully.
- After changing the bevel angle, always secure the arm by tightening the lever clockwise.
- When changing bevel angles, be sure to position the kerf boards appropriately as explained in the "Positioning kerf boards" section.

Adjusting the lever position

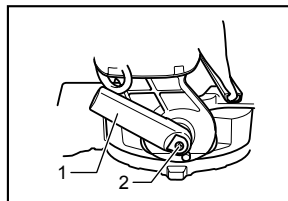

003932

1. Lever
2. Screw

The lever can be repositioned at every angle 30° when the lever does not provide full tightening.

Loosen and remove the screw that secures the lever at the rear of the tool. Remove the lever and install it again

so that it is slightly above the level. Secure the lever with the screw firmly.

Switch action

⚠ CAUTION:

- Before plugging in the tool, always check to see that the switch trigger actuates properly and returns to the "OFF" position when released.
- When not using the tool, remove the lock-off button and store it in a secure place. This prevents unauthorized operation.
- Do not pull the switch trigger hard without pressing in the lock-off button. This can cause switch breakage.

For European countries

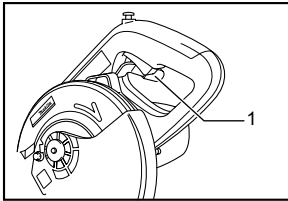

1. Lever

005517

To prevent the switch trigger from being accidentally pulled, a lock-off button is provided. To start the tool, push the lever to the left, press in the lock-off button and then pull the switch trigger. Release the switch trigger to stop.

For all countries other than European countries

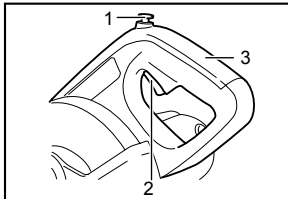

1. Lock-off button
2. Switch trigger
3. Handle

002253

To prevent the switch trigger from being accidentally pulled, a lock-off button is provided. To start the tool, press in the lock-off button and pull the switch trigger. Release the switch trigger to stop.

⚠ WARNING:

- NEVER use tool without a fully operative switch trigger. Never use tool with an inoperative switch is **HIGHLY DANGEROUS** and must be repaired before further usage.
- For your safety, this tool is equipped with a lock-off button which prevents the tool from unintended starting. NEVER use the tool if it runs when you simply pull the switch trigger without pressing the lock-off button. Return tool to a Makita service

center for proper repairs BEFORE further usage.

- NEVER tape down or defeat purpose and function of lock-off button.

Lighting up the lamps

For model LS0714F, LS0714FL

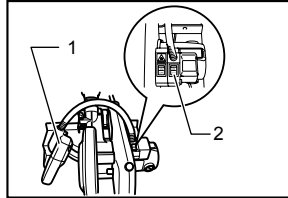

1. Light
2. Light switch

005518

⚠ CAUTION:

- This is not a rainproof light. Do not wash the light in water or use it in a rain or a wet area. Such a conduct can cause an electric shock and fume.
- Do not touch the lens of the light, as it is very hot while it is lighted or shortly after it is turned off. This may cause a burn to a human body.
- Do not apply impact to the light, which may cause damage or shortened service time to it.
- Do not keep casting the beam of the light to your eyes. This can cause your eyes to be hurt.
- Do not cover the light with clothes, carton, cardboard or similar objects while it is lighted, which can cause a fire or an ignition.

Push the upper position of the switch for turning on the light and the lower position for off.

Move the light to shift an area of lighting.

NOTE:

- Use a dry cloth to wipe the dirt off the lens of lamp. Be careful not to scratch the lens of light, or it may lower the illumination.

Laser beam action

For model LS0714FL, LS0714L

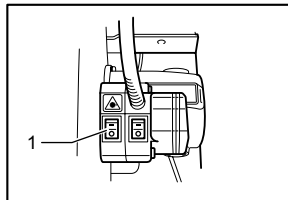

1. Switch for laser

005519

⚠ CAUTION:

- Never look into the laser beam. Direct laser beam may injure your eyes.

- LASER RADIATION, DO NOT STARE INTO THE BEAM OR VIEW DIRECTLY WITH OPTICAL INSTRUMENTS, CLASS 2M LASER PRODUCT.

To turn on the laser beam, press the upper position (I) of the switch. Press the lower position (O) to turn off.

Laser line can be shifted to either the left or right side of the saw blade by adjusting the adjusting screw as follows.

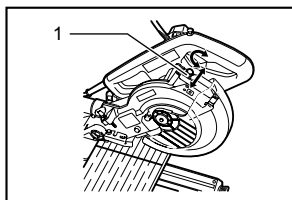

1. Adjusting screw

005520

1. Loosen the adjusting screw by turning it counterclockwise.
2. With the adjusting screw loosened, slide the adjusting screw to the right or left as far as it goes.
3. Tighten the adjusting screw firmly at the position where it stops sliding.

Laser line is factory adjusted so that it is positioned within 1 mm from the side surface of the blade (cutting position).

NOTE:

- When laser line is dim and almost or entirely invisible because of the direct sunlight in the indoor or outdoor window-by work, relocate the work area to a place not exposed to the direct sunlight.

Aligning the laser line

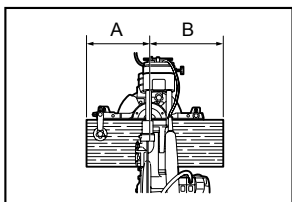

005521

Laser line can be shifted to either the left or right side of the blade according to the applications of cutting. Refer to explanation titled "Laser beam action" regarding its shifting method.

NOTE:

- Use wood facing against the guide fence when aligning the cutting line with the laser line at the side of guide fence in compound cutting (bevel angle 45 degrees and miter angle right 45 degrees).

A) When you obtain correct size on the left side of workpiece

- Shift the laser line to the left of the blade.
- B) When you obtain correct size on the right side of workpiece

- Shift the laser line to the right of the blade.
- Align the cutting line on your workpiece with the laser line.

ASSEMBLY

⚠WARNING:

- Always be sure that the tool is switched off and unplugged before carrying out any work on the tool.

Hex wrench storage

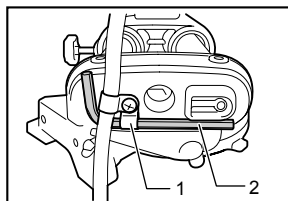

1. Wrench holder
2. Hex wrench

012596

The hex wrench is stored as shown in the figure. When using the hex wrench, pull it out of the wrench holder. After using the hex wrench, return it to the wrench holder.

Installing or removing saw blade

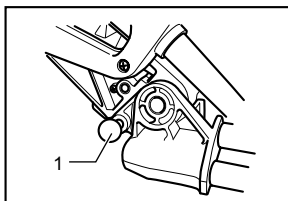

1. Stopper pin

003923

⚠WARNING:

- Always be sure that the tool is switched off and unplugged before installing or removing the blade.

⚠CAUTION:

- Use only the Makita hex wrench provided to install or remove the blade. Failure to do so may result in overtightening or insufficient tightening of the hex socket bolt. This could cause an injury.

Lock the handle in the raised position by pushing in the stopper pin.

To remove the blade, use the hex wrench to loosen the hex socket bolt holding the center cover by turning it counterclockwise. Raise the blade guard and center cover.

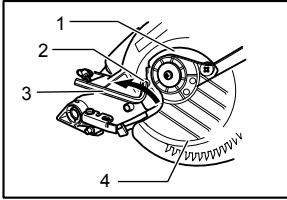

1. Center cover
2. Hex socket bolt
3. Hex wrench
4. Safety cover

012586

Press the shaft lock to lock the spindle and use the hex wrench to loosen the hex socket bolt clockwise. Then remove the hex socket bolt, outer flange and blade.

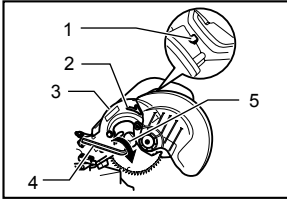

1. Shaft lock
2. Arrow
3. Blade case
4. Hex wrench
5. Hex socket bolt

012587

To install the blade, mount it carefully onto the spindle, making sure that the direction of the arrow on the surface of the blade matches the direction of the arrow on the blade case. Install the outer flange and hex socket bolt (left-handed) securely counterclockwise while pressing the shaft lock.

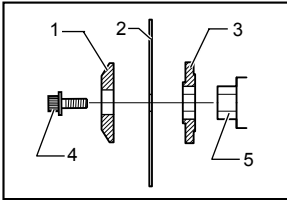

1. Outer flange
2. Saw blade
3. Inner flange
4. Hex socket bolt (left-handed)
5. Spindle

012719

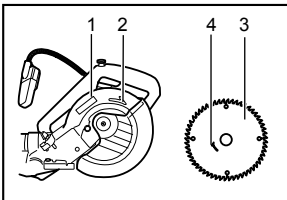

1. Blade case
2. Arrow
3. Saw blade
4. Arrow

005523

Return the blade guard and center cover to its original position. Then tighten the hex socket bolt clockwise to secure the center cover. Release the handle from the raised position by pulling the stopper pin. Lower the handle to make sure that the blade guard moves properly.

Make sure shaft lock has released spindle before making cut.

Dust bag (optional accessory)

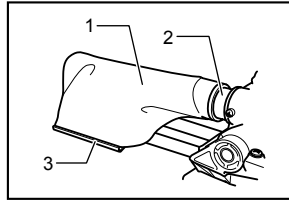

1. Dust bag
2. Dust nozzle
3. Fastener

003937

The use of the dust bag makes cutting operations clean and dust collection easy. To attach the dust bag, fit it onto the dust nozzle.

When the dust bag is about half full, remove the dust bag from the tool and pull the fastener out. Empty the dust bag of its contents, tapping it lightly so as to remove particles adhering to the insides which might hamper further collection.

NOTE:

If you connect a Makita vacuum cleaner to your saw, more efficient and cleaner operations can be performed.

Dust box (Optional accessory)

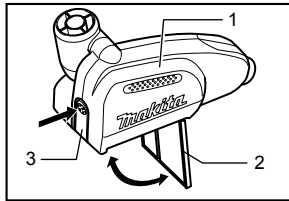

1. Dust box
2. Cover
3. Button

006793

Insert the dust box into the dust nozzle.

Empty the dust box at the earliest possible.

To empty the dust box, open the cover by pushing the button and throw away sawdust. Return the cover to the original position and it locks. Dust box can easily be removed by pulling out while turning it near the dust nozzle on the tool.

NOTE:

- If you connect a Makita vacuum cleaner to this tool, more efficient and cleaner operations can be performed.

⚠CAUTION:

- Empty the dust box before collected sawdust level reaches the cylinder part.

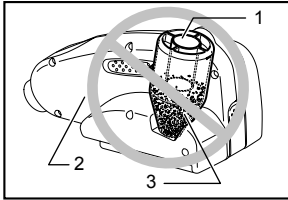

1. Cylinder part
2. Dust box
3. Sawdust

006792

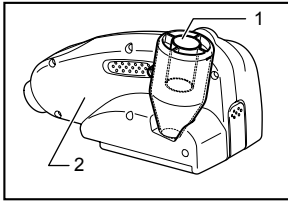

1. Cylinder part
2. Dust box

006794

Securing workpiece

⚠WARNING:

- It is extremely important to always secure the workpiece properly and tightly with the vise. Failure to do so can cause the tool to be damaged and/or the workpiece to be destroyed. **PERSONAL INJURY MAY ALSO RESULT.** Also, after a cutting operation, **DO NOT** raise the blade until the blade has come to a complete stop.

⚠CAUTION:

- When cutting long workpieces, use supports that are as high as the top surface level of the turn base. Do not rely solely on the vertical vise and/or horizontal vise to secure the workpiece. Thin material tends to sag. Support workpiece over its entire length to avoid blade pinch and possible **KICKBACK.**

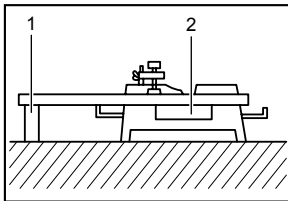

1. Support
2. Turn base

001549

Vertical vise

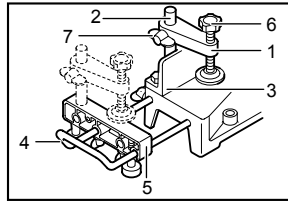

1. Vise arm
2. Vise rod
3. Guide fence
4. Holder
5. Holder assembly
6. Vise knob
7. Screw

002255

The vertical vise can be installed in two positions on either the left or right side of the guide fence or the holder assembly (optional accessory). Insert the vise rod into the hole in the guide fence or the holder assembly and tighten the screw to secure the vise rod.

Position the vise arm according to the thickness and shape of the workpiece and secure the vise arm by tightening the screw. If the screw to secure the vise arm contacts the guide fence, install the screw on the opposite side of vise arm. Make sure that no part of the tool contacts the vise when lowering the handle fully and pulling or pushing the carriage all the way. If some part contacts the vise, re-position the vise.

Press the workpiece flat against the guide fence and the turn base. Position the workpiece at the desired cutting position and secure it firmly by tightening the vise knob.

⚠CAUTION:

- The workpiece must be secured firmly against the turn base and guide fence with the vise during all operations.

Horizontal vise (optional accessory)

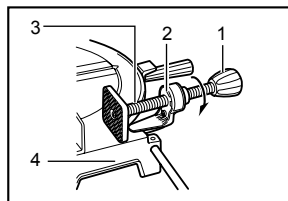

1. Vise knob
2. Projection
3. Vise shaft
4. Base

001807

The horizontal vise can be installed on the left side of the base. By turning the vise knob counterclockwise, the screw is released and the vise shaft can be moved rapidly in and out. By turning the vise knob clockwise, the screw remains secured. To grip the workpiece, turn the vise knob gently clockwise until the projection reaches its topmost position, then fasten securely. If the vise knob is forced in or pulled out while being turned clockwise, the projection may stop at an angle. In this case, turn the vise knob back counterclockwise until the screw is released, before turning again gently clockwise.

The maximum width of the workpiece which can be secured by the horizontal vise is 120 mm.

⚠CAUTION:

- Grip the workpiece only when the projection is at the topmost position. Failure to do so may result in insufficient securing of the workpiece. This could cause the workpiece to be thrown, cause damage to the blade or cause the loss of control, which can result in PERSONAL INJURY.

Holders and holder assembly (optional accessories)

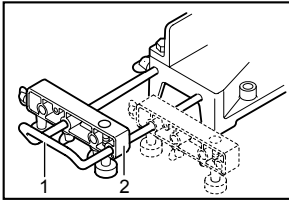

1. Holder
2. Holder assembly

002247

The holders and the holder assembly can be installed on either side as a convenient means of supporting workpieces horizontally. Install them as shown in the figure. Then tighten the screws firmly to secure the holders and the holder assembly.

When cutting long workpieces, use the holder-rod assembly (optional accessory). It consists of two holder assemblies and two rods 12.

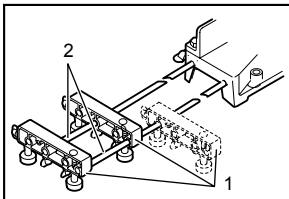

1. Holder assembly
2. Rod 12

002246

⚠CAUTION:

- Always support long workpieces level with the top surface of the turn base for accurate cuts and to prevent dangerous loss of control of the tool.

OPERATION

⚠CAUTION:

- Before use, be sure to release the handle from the lowered position by pulling the stopper pin.
- Make sure the blade is not contacting the workpiece, etc. before the switch is turned on.
- Do not apply excessive pressure on the handle when cutting. Too much force may result in

overload of the motor and/or decreased cutting efficiency. Push down handle with only as much force as is necessary for smooth cutting and without significant decrease in blade speed.

- Gently press down the handle to perform the cut. If the handle is pressed down with force or if lateral force is applied, the blade will vibrate and leave a mark (saw mark) in the workpiece and the precision of the cut will be impaired.
- During a slide cut, gently push the carriage toward the guide fence without stopping. If the carriage movement is stopped during the cut, a mark will be left in the workpiece and the precision of the cut will be impaired.

1. Press cutting (cutting small workpieces)

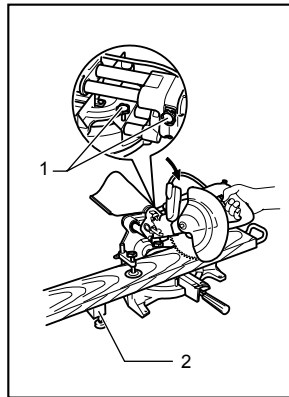

1. Two clamping screws which secure the slide pole
2. Holder assembly (optional accessory)

005524

Workpieces up to 50 mm high and 97 mm wide can be cut in the following way.

Push the carriage toward the guide fence fully and tighten two clamp screws which secure the slide poles clockwise to secure the carriage. Secure the workpiece with the vise. Switch on the tool without the blade making any contact and wait until the blade attains full speed before lowering. Then gently lower the handle to the fully lowered position to cut the workpiece. When the cut is completed, switch off the tool and **WAIT UNTIL THE BLADE HAS COME TO A COMPLETE STOP** before returning the blade to its fully elevated position.

⚠CAUTION:

- Firmly tighten two clamping screws which secure the slide poles clockwise so that the carriage will not move during operation. Insufficient tightening may cause unexpected kickback of the blade. Possible serious PERSONAL INJURY may result.

2. Slide (push) cutting (cutting wide workpieces)

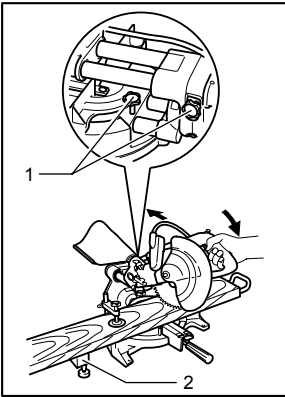

005525

1. Two clamping screws which secure the slide pole
2. Holder assembly (optional accessory)

Loosen two clamp screws which secure the slide poles counterclockwise so that the carriage can slide freely. Secure the workpiece with the vise. Pull the carriage toward you fully. Switch on the tool without the blade making any contact and wait until the blade attains full speed. Press down the handle and PUSH THE CARRIAGE TOWARD THE GUIDE FENCE AND THROUGH THE WORKPIECE. When the cut is completed, switch off the tool and WAIT UNTIL THE BLADE HAS COME TO A COMPLETE STOP before returning the blade to its fully elevated position.

⚠CAUTION:

- Whenever performing the slide cut, FIRST PULL THE CARRIAGE TOWARD YOU FULLY and press down the handle to the fully lowered position, then PUSH THE CARRIAGE TOWARD THE GUIDE FENCE. NEVER START THE CUT WITH THE CARRIAGE NOT FULLY PULLED TOWARD YOU. If you perform the slide cut without pulling the carriage fully or if you perform the slide cut toward your direction, the blade may kickback unexpectedly with the potential to cause serious PERSONAL INJURY.
- Never perform the slide cut with the handle locked in the lowered position by pressing the stopper pin.
- Never loosen the clamp screw which secures the carriage while the blade is rotating. This may cause serious injury.

3. Miter cutting

Refer to the previously covered "Adjusting the miter angle".

4. Bevel cut

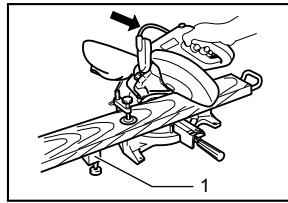

005526

1. Holder assembly (optional accessory)

Loosen the lever and tilt the saw blade to set the bevel angle (Refer to the previously covered "Adjusting the bevel angle"). Be sure to retighten the lever firmly to secure the selected bevel angle safely. Secure the workpiece with a vise. Make sure the carriage is pulled all the way back toward the operator. Switch on the tool without the blade making any contact and wait until the blade attains full speed. Then gently lower the handle to the fully lowered position while applying pressure in parallel with the blade and PUSH THE CARRIAGE TOWARD THE GUIDE FENCE TO CUT THE WORKPIECE. When the cut is completed, switch off the tool and WAIT UNTIL THE BLADE HAS COME TO A COMPLETE STOP before returning the blade to its fully elevated position.

⚠CAUTION:

- Always be sure that the blade will move down to bevel direction during a bevel cut. Keep hands out of path of saw blade.
- During a bevel cut, it may create a condition whereby the piece cut off will come to rest against the side of the blade. If the blade is raised while the blade is still rotating, this piece may be caught by the blade, causing fragments to be scattered which is dangerous. The blade should be raised ONLY after the blade has come to a complete stop.
- When pressing the handle down, apply pressure parallel to the blade. If the pressure is not parallel to the blade during a cut, the angle of the blade might be shifted and the precision of the cut will be impaired.

5. Compound cutting

Compound cutting is the process in which a bevel angle is made at the same time in which a miter angle is being cut on a workpiece. Compound cutting can be performed at the angle shown in the table.

Miter angle	Bevel angle
Left and Right 45°	Left 0° - 45°
Right 50°	Left 0° - 40°
Right 55°	Left 0° - 30°
Right 57°	Left 0° - 25°

006393

When performing compound cutting, refer to "Press cutting", "Slide cutting", "Miter cutting" and "Bevel cut" explanations.

6. Cutting crown and cove moldings

Crown and cove moldings can be cut on a compound miter saw with the moldings laid flat on the turn base.

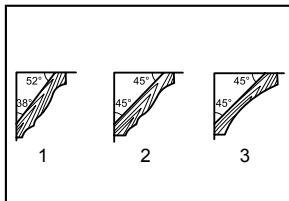

001555

- 52/38° type crown molding
- 45° type crown molding
- 45° type cove molding

There are two common types of crown moldings and one type of cove moldings; 52/38° wall angle crown molding, 45° wall angle crown molding and 45° wall angle cove molding. See illustrations.

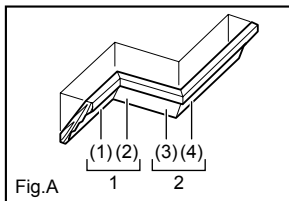

001556

- Inside corner
- Outside corner

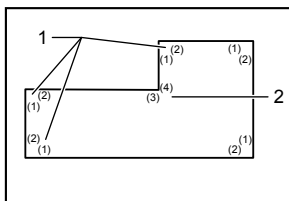

001557

- Inside corner
- Outside corner

There are crown and cove molding joints which are made to fit "Inside" 90° corners ((1) and (2) in Fig. A) and "Outside" 90° corners ((3) and (4) in Fig. A).

Measuring

Measure the wall length and adjust workpiece on table to cut wall contact edge to desired length. Always make sure that cut workpiece length **at the**

back of the workpiece is the same as wall length. Adjust cut length for angle of cut. Always use several pieces for test cuts to check the saw angles.

When cutting crown and cove moldings, set the bevel angle and miter angle as indicated in the table (A) and position the moldings on the top surface of the saw base as indicated in the table (B).

In the case of left bevel cut

Table (A)

	Molding position in Fig. A	Bevel angle		Miter angle	
		52/38° type	45° type	52/38° type	45° type
For inside corner	(1)	Left 33.9°	Left 30°	Right 31.6°	Right 35.3°
	(2)				
For outside corner	(3)			Left 31.6°	Left 35.3°
	(4)				

006361

Table (B)

	Molding position in Fig. A	Molding edge against guide fence	Finished piece
For inside corner	(1)	Ceiling contact edge should be against guide fence.	Finished piece will be on the Left side of blade.
	(2)	Wall contact edge should be against guide fence.	
For outside corner	(3)	Ceiling contact edge should be against guide fence.	Finished piece will be on the Right side of blade.
	(4)		

006362

Example:

In the case of cutting 52/38° type crown molding for position (1) in Fig. A:

- Tilt and secure bevel angle setting to 33.9° LEFT.
- Adjust and secure miter angle setting to 31.6° RIGHT.
- Lay crown molding with its broad back (hidden) surface down on the turn base with its CEILING CONTACT EDGE against the guide fence on the saw.
- The finished piece to be used will always be on the LEFT side of the blade after the cut has been made.

In the case of right bevel cut

Table (A)

	Molding position in Fig. A	Bevel angle		Miter angle	
		52/38° type	45° type	52/38° type	45° type
For inside corner	(1)	Right 33.9°	Right 30°	Right 31.6°	Right 35.3°
	(2)				
For outside corner	(3)			Left 31.6°	Left 35.3°
	(4)				

006363

Table (B)

	Molding position in Fig. A	Molding edge against guide fence	Finished piece
For inside corner	(1)	Wall contact edge should be against guide fence.	Finished piece will be on the Right side of blade.
	(2)	Ceiling contact edge should be against guide fence.	
For outside corner	(3)	Wall contact edge should be against guide fence.	Finished piece will be on the Left side of blade.
	(4)	Wall contact edge should be against guide fence.	

006364

Example:

In the case of cutting 52/38° type crown molding for position (1) in Fig. A:

- Tilt and secure bevel angle setting to 33.9° RIGHT.
- Adjust and secure miter angle setting to 31.6° RIGHT.
- Lay crown molding with its broad back (hidden) surface down on the turn base with its WALL CONTACT EDGE against the guide fence on the saw.
- The finished piece will be used will always be on the RIGHT side of the blade after the cut has been made.

7. Cutting aluminum extrusion

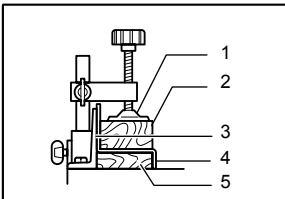

001844

1. Vise
2. Spacer block
3. Guide fence
4. Aluminum extrusion
5. Spacer block

When securing aluminum extrusions, use spacer blocks or pieces of scrap as shown in the figure to prevent deformation of the aluminum. Use a cutting lubricant when cutting the aluminum extrusion to prevent build-up of the aluminum material on the blade.

⚠ CAUTION:

- Never attempt to cut thick or round aluminum extrusions. Thick aluminum extrusions may come loose during operation and round aluminum extrusions cannot be secured firmly with this tool.

8. Wood facing

Use of wood facing helps to assure splinter-free cuts in workpieces. Attach a wood facing to the guide fence using the holes in the guide fence.

See the figure concerning the dimensions for a suggested wood facing.

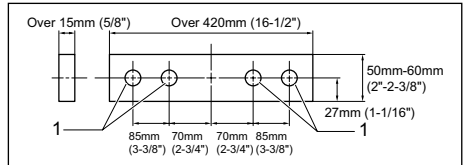

1. Holes

002206

⚠ CAUTION:

- Use straight wood of even thickness as the wood facing.
- Use screws to attach the wood facing to the guide fence. The screws should be installed so that the screw heads are below the surface of the wood facing.
- When the wood facing is attached, do not turn the turn base with the handle lowered. The blade and/or the wood facing will be damaged.

9. Cutting repetitive lengths

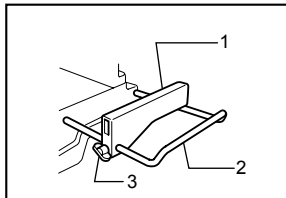

001846

1. Set plate
2. Holder
3. Screw

When cutting several pieces of stock to the same length, ranging from 220 mm to 385 mm, use of the set plate (optional accessory) will facilitate more efficient operation. Install the set plate on the holder (optional accessory) as shown in the figure.

Align the cutting line on your workpiece with either the left or right side of the groove in the kerf board, and while holding the workpiece from moving, move the set plate flush against the end of the workpiece. Then secure the set plate with the screw. When the set plate is not used, loosen the screw and turn the set plate out of the way.

NOTE:

- Use of the holder-rod assembly (optional accessory) allows cutting repetitive lengths up to 2,200 mm approximately.

10. Groove cutting

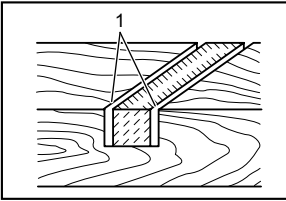

001563

1. Cut grooves with blade

A dado type cut can be made by proceeding as follows:

Adjust the lower limit position of the blade using the adjusting screw and the stopper arm to limit the cutting depth of the blade. Refer to "Stopper arm" section described on previously.

After adjusting the lower limit position of the blade, cut parallel grooves across the width of the workpiece using a slide (push) cut as shown in the figure. Then remove the workpiece material between the grooves with a chisel. Do not attempt to perform this type of cut using wide (thick) blades or with a dado blade. Possible loss of control and injury may result.

⚠CAUTION:

- Be sure to return the stopper arm to the original position when performing other than groove cutting.

Carrying tool

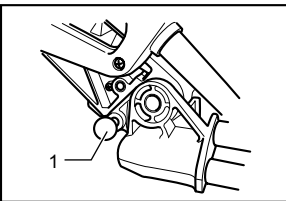

003923

1. Stopper pin

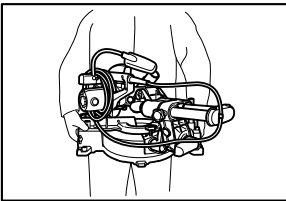

012607

Make sure that the tool is unplugged. Secure the blade at 0° bevel angle and the turn base at the full right miter angle position. Secure the slide poles so that the lower slide pole is locked in the position of the carriage fully

pulled to operator and the upper poles are locked in the position of the carriage fully pushed forward to the guide fence. Lower the handle fully and lock it in the lowered position by pushing in the stopper pin.

Carry the tool by holding both sides of the tool base as shown in the figure. If you remove the holders, dust bag, etc., you can carry the tool more easily.

⚠CAUTION:

- Always secure all moving portions before carrying the tool.
- Stopper pin is for carrying and storage purposes only and not for any cutting operations.

MAINTENANCE

⚠CAUTION:

- Always be sure that the tool is switched off and unplugged before attempting to perform inspection or maintenance.
- Never use gasoline, benzine, thinner, alcohol or the like. Discoloration, deformation or cracks may result.

⚠WARNING:

- Always be sure that the blade is sharp and clean for the best and safest performance.

Adjusting the cutting angle

This tool is carefully adjusted and aligned at the factory, but rough handling may have affected the alignment. If your tool is not aligned properly, perform the following:

1. Miter angle

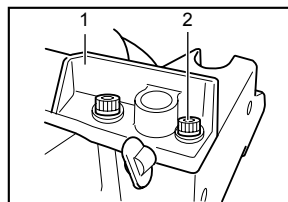

012585

1. Guide fence
2. Hex socket bolt

Push the carriage toward the guide fence and tighten two clamp screws to secure the carriage.

Loosen the grip which secures the turn base. Turn the turn base so that the pointer points to 0° on the miter scale. Then turn the turn base slightly clockwise and counterclockwise to seat the turn base in the 0° miter notch. (Leave as it is if the pointer does not point to 0°.) Loosen the hex socket bolt securing the guide fence using the hex wrench. Lower the handle fully and lock it in the lowered position by pushing in the stopper pin. Square the

side of the blade with the face of the guide fence using a triangular rule, try-square, etc. Then securely tighten the hex socket bolt on the guide fence in the order from the right side.

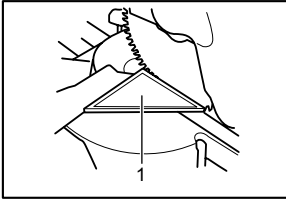

002209

1. Triangular rule

Make sure that the pointer points to 0° on the miter scale. If the pointer does not point to 0°, loosen the screw which secures the pointer and adjust the pointer so that it will point to 0°.

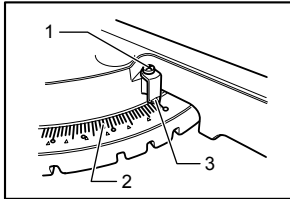

003942

1. Screw
2. Miter scale
3. Pointer

2. Bevel angle

(1) 0° bevel angle

Push the carriage toward the guide fence and tighten two clamp screws to secure the carriage. Lower the handle fully and lock it in the lowered position by pushing in the stopper pin. Loosen the lever at the rear of the tool.

Turn the 0° bevel angle adjusting bolt (lower bolt) on the right side of the arm two or three revolutions counterclockwise to tilt the blade to the right.

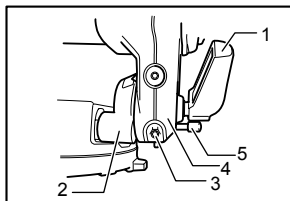

012589

1. Lever
2. Arm holder
3. 0° degree bevel angle adjusting bolt
4. Arm
5. Release button

Carefully square the side of the blade with the top surface of the turn base using the triangular rule, try-square, etc. by turning the 0° bevel angle adjusting bolt clockwise. Then tighten the lever securely.

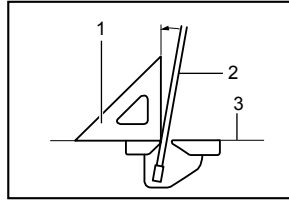

001819

1. Triangular rule
2. Saw blade
3. Top surface of turn table

Make sure that the pointer on the arm points to 0° on the bevel scale on the arm holder. If it does not point to 0°, loosen the screw which secures the pointer and adjust the pointer so that it will point to 0°.

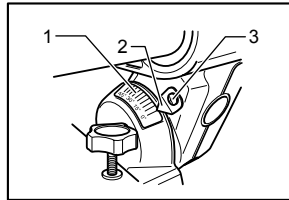

003944

1. Bevel scale
2. Pointer
3. Screw

(2) 45° bevel angle

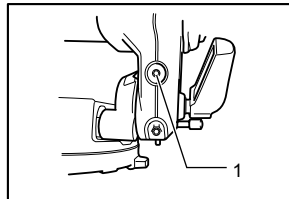

012590

1. Left 45° bevel angle adjusting bolt

Adjust the 45° bevel angle only after performing 0° bevel angle adjustment. To adjust left 45° bevel angle, loosen the lever and tilt the blade to the left fully. Make sure that the pointer on the arm points to 45° on the bevel scale on the arm holder. If the pointer does not point to 45°, turn the 45° bevel angle adjusting bolt (upper bolt) on the right side of the arm until the pointer points to 45°.

Adjusting the position of laser line

For model LS0714FL, LS0714L

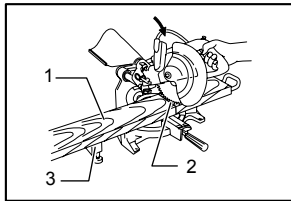

005701

1. Workpiece
2. Cutting line
3. Holder assembly (optional accessory)

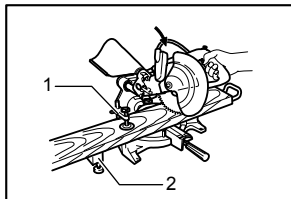

005702

1. Vertical vise
2. Holder assembly (optional accessory)

⚠ WARNING:

- As the tool is plugged when adjusting the position of laser line, take a full caution especially at switch action. Pulling the switch trigger accidentally cause an accidental start of the tool and personal injury.

⚠ CAUTION:

- Never look into the laser beam directly. Direct laser beam causes damage to your eyes.
- Never apply a blow or impact to the tool. A blow or impact causes the incorrect position of laser line, damage to the laser beam emitting part or a short life of the tool.
- Have the tool repaired by Makita authorized service center for any failure on the laser unit. No change with different type of laser is permitted.

When adjusting the laser line appears on the left side of the saw blade

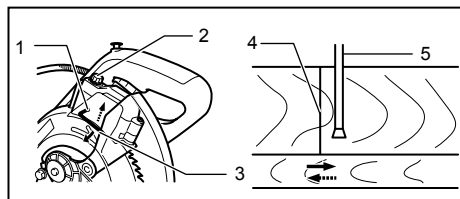

1. Screw to change the movable range of the adjusting screw
2. Adjusting screw
3. Hex wrench
4. Laser line
5. Saw blade

005527

When adjusting the laser line appears on the right side of the saw blade

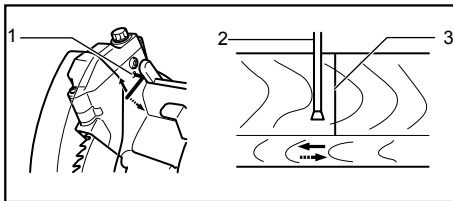

1. Screw to change the movable range of the adjusting screw
2. Saw blade
3. Laser line

005528

For both adjustments, do as follows.

1. Make sure that the tool is unplugged.
2. Draw the cutting line on the workpiece and place it on the turn table. At this time, do not secure the workpiece with a vise or similar securing device.
3. Lower the blade by lowering the handle and just check to see where the cutting line and the position of the saw blade is. (Decide which position to cut on the line of cut.)
4. After decision the position to be cut, return the handle to the original position. Secure the workpiece with the vertical vise without shifting the workpiece from the pre-checked position.
5. Plug the tool and turn on the laser switch.
6. Adjust the position of laser line as follows.

The position of laser line can be changed as the movable range of the adjusting screw for the laser is changed by turning two screws with a hex wrench. (The movable range of laser line is factory adjusted within 1 mm from the side surface of blade.)

To shift the laser line movable range further away from the side surface of blade, turn the two screws counterclockwise after loosening the adjusting screw. Turn these two screws clockwise to shift it closer to the side surface of the blade after loosening the adjusting screw.

Refer to the section titled "Laser line action" and adjust the adjusting screw so that the cutting line on your workpiece is aligned with the laser line.

NOTE:

- Check the position of laser line regularly for accuracy.
- Have the tool repaired by Makita authorized service center for any failure on the laser unit.

Replacing fluorescent tube

For model LS0714F, LS0714FL only

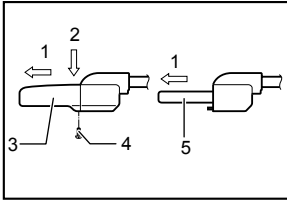

002028

CAUTION:

- Always be sure that the tool is switched off and unplugged before replacing the fluorescent tube.
- Do not apply force, impact or scratch to a fluorescent tube, which can cause a glass of the fluorescent tube to be broken resulting in a injury to you or your bystanders.
- Leave the fluorescent tube for a while immediately after a use of it and then replace it. If not. You may burn yourself.

Remove screws, which secure Lamp Box for the light. Pull out the Lamp Box keeping pushing lightly the upper position of it as illustrated on the left. Pull out the fluorescent tube and then replace it with Makita original new one.

Cleaning of the lens for the laser light

For model LS0714FL, LS0714L

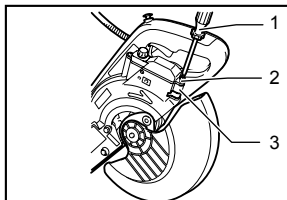

005703

If the lens for the laser light becomes dirty, or sawdust adheres to it in such a way that the laser line is no longer easily visible, unplug the saw and remove and clean the lens for the laser light carefully with a damp, soft cloth. Do not use solvents or any petroleum-based cleaners on the lens.

1. Pull out
2. Push
3. Lamp box
4. Screws
5. Fluorescent tube

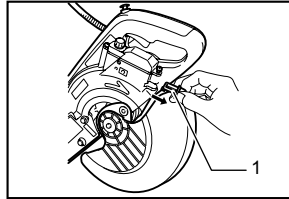

005704

To remove the lens for the laser light, remove the saw blade before removing the lens according to the instructions in the section titled "Installing or removing saw blade".

Loosen but do not remove the screw which secures the lens using a screwdriver.

Pull out the lens as shown in the figure.

NOTE:

- If the lens does not come out, loosen the screw further and pull out the lens again without removing the screw.

Replacing carbon brushes

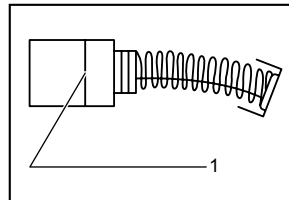

001145

Remove and check the carbon brushes regularly. Replace when they wear down to the limit mark. Keep the carbon brushes clean and free to slip in the holders. Both carbon brushes should be replaced at the same time. Use only identical carbon brushes.

Use a screwdriver to remove the brush holder caps. Take out the worn carbon brushes, insert the new ones and secure the brush holder caps.

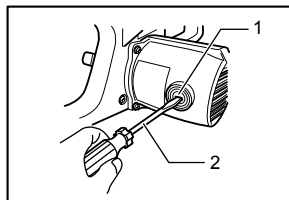

003946

After use

- After use, wipe off chips and dust adhering to the tool with a cloth or the like. Keep the blade guard

clean according to the directions in the previously covered section titled "Blade guard". Lubricate the sliding portions with machine oil to prevent rust.

- When storing the tool, pull the carriage toward you fully so that the slide pole is thoroughly inserted into the turn base.

To maintain product SAFETY and RELIABILITY, repairs, any other maintenance or adjustment should be performed by Makita Authorized Service Centers, always using Makita replacement parts.

OPTIONAL ACCESSORIES

CAUTION:

- These accessories or attachments are recommended for use with your Makita tool specified in this manual. The use of any other accessories or attachments might present a risk of injury to persons. Only use accessory or attachment for its stated purpose.

If you need any assistance for more details regarding these accessories, ask your local Makita Service Center.

- Carbide-tipped saw blades
- Vise assembly (Horizontal vise)
- Vertical vise
- Holder set
- Holder assembly
- Holder rod assembly
- Set plate
- Dust bag
- Triangular rule
- Lock-off button (2 pcs.)
- Fluorescent tube
- Hex wrench

NOTE:

- Some items in the list may be included in the tool package as standard accessories. They may differ from country to country.

Makita Corporation
Anjo, Aichi, Japan

884547H226

www.makita.com