

Model No. GA7060R 180MM ANGLE GRINDER

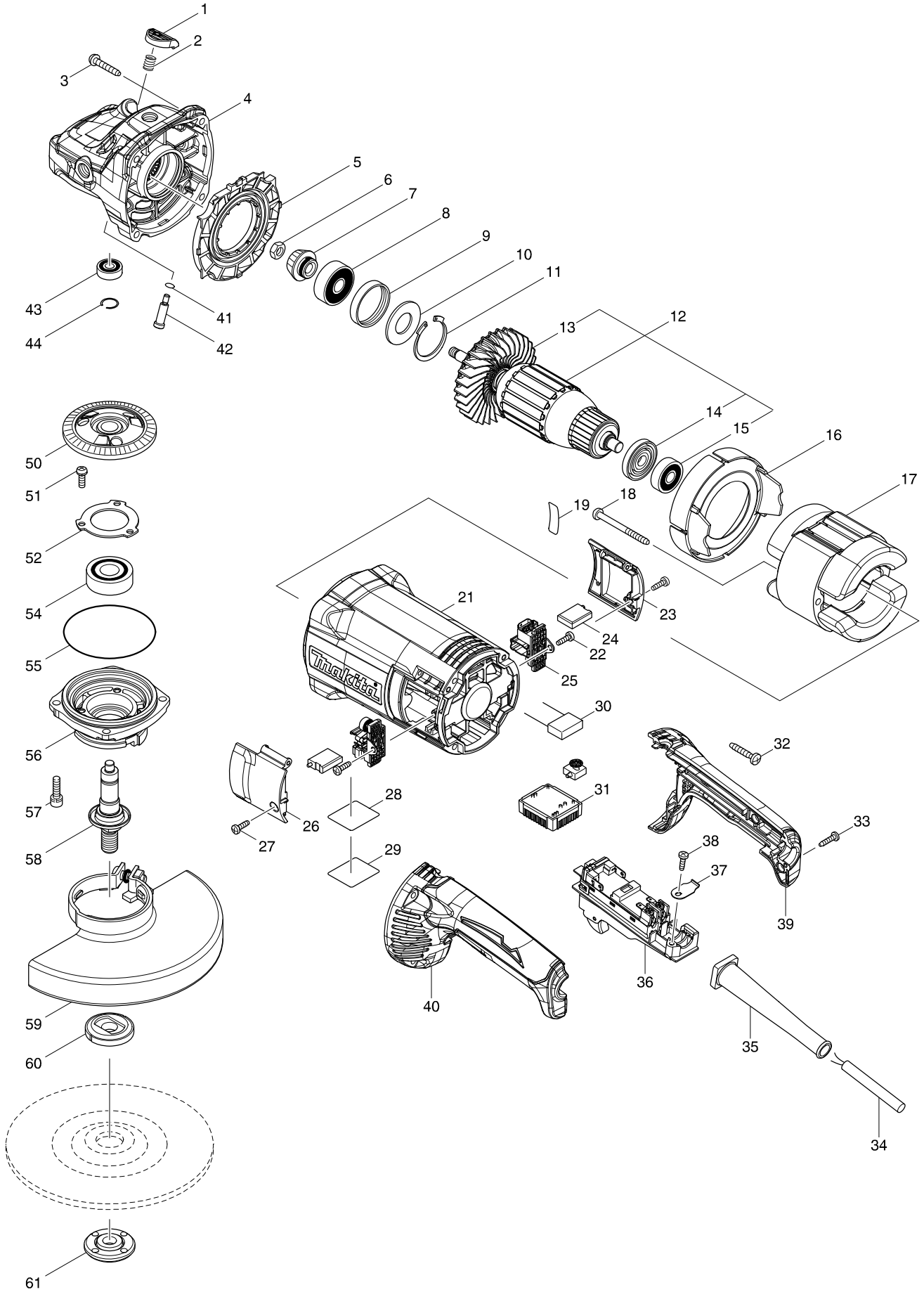

Model No. GA7060R 180MM ANGLE GRINDER

Item	Parts No.	Description	I/C	Qty	N/O	Sales	Purch.	Note
001	456247-8	PIN CAP		1				
002	234391-9	COMPRESSION SPRING 8		1				
003	251489-7	TAPPING SCREW 5X30		4				
004	143485-8	GEAR HOUSING COMPLETE		1				
C10	263002-9	RUBBER PIN 4		1				
005	456238-9	DIFFUSER		1				
006	252194-9	HEX. NUT M8		1				
007	227655-8	SPIRAL BEVEL GEAR 17		1				
008	211132-0	BALL BEARING 6301DDW		1				
009	262085-6	RUBBER RING 38		1				
010	267299-2	FLAT WASHER 20		1				
011	962211-4	RETAINING RING R-42		1				
012	518175-6	ARMATURE ASS'Y 220V		1				
D10		INC. 13-15						
013	240161-6	FAN 86		1				
014	681630-2	INSULATION WASHER		1				
015	211087-9	BALL BEARING 6200DDW		1				
016	456239-7	BAFFLE PLATE		1				
017	621778-8	FIELD 220V		1				
018	266044-2	TAPPING SCREW 5X60		2				
019	851V07-9	GA7060R SERIAL NO. LABEL		1				
021	456240-2	MOTOR HOUSING		1				
022	266385-6	TAPPING SCREW 4X14		2				
023	143950-7	BRUSH HOLDER COVER R COMPLETE		1				
024	197129-2	CARBON BRUSH CB-218		1				
025	643714-4	BRUSH HOLDER		2				
026	143949-2	BRUSH HOLDER COVER L COMPLETE		1				
027	266385-6	TAPPING SCREW 4X14		2				
028	851V04-5	GA7060R NAME PLATE		1				
029	808D02-2	CLEAR LABEL		1				
031	620470-3	CONTROLLER		1				
032	251489-7	TAPPING SCREW 5X30		4				
033	266326-2	TAPPING SCREW 4X18		2				
034	692607-2	POWER SUPPLY CORD 1.5-2-2.5		1				
035	682573-1	CORD GUARD 10		1				
036	632F77-9	SWITCH UNIT		1				
037	687169-3	STRAIN RELIEF		1				
038	266385-6	TAPPING SCREW 4X14		1				
039	183C62-2	HANDLE SET		1				
D10		INC. 40						
040	183C62-2	HANDLE SET		1				
D10		INC. 39						
041	213026-5	O RING 7		1				
042	256571-7	SHOULDER PIN 7		1				
043	211032-4	BALL BEARING 608ZZ		1				
044	233925-5	RING SPRING 13		1				
050	227656-6	SPIRAL GEAR 55		1				
051	265120-9	PAN HEAD SCREW M5X16		3				

